

# MODCO 5 - 30 X 30

MODCO MODULAR EXHIBITS  
 PRODUCT CODE: MODCO5-30x30G

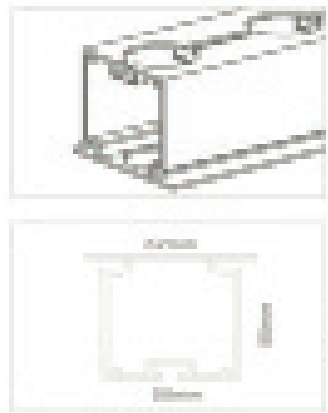

## PRODUCT DESCRIPTION

Modco Modular Exhibits Modular 5 is a three-dimensional 30' x 30' pre-designed exhibit booth. Stylish and lively, Modco Modular Exhibits Modular 5 is built using tool-free perforated modular aluminum frames. Multiple frames connect using simple toolless pin connectors to create a center tower with arches all around. Use counters to showcase your products. Customize double-sided stretch fabric SEG graphics for the entire exhibit. Perforations are completely covered for a flawless finish.

DISPLAY DIMENSIONS	269"W x 190.5"H x 264"D		
GRAPHIC SIZES	PANEL	SIZE	QTY
	A	40.125"W x 79.125"H	8
	B1	40.125"W x 96.25"H	15
	G	40.125"W x 40.125"H	8
	O	35.25"W x 94.375"H	1
	M	13.25"W x 40.125"H	8
	Q1	39.625"W x 31"H	4
	Q2	39.625"W x 27.75"H	4
TOTAL PRINTS			48

## GRAPHIC MATERIAL

Stretch Fabric w/Integrated Block Out

## GRAPHIC FINISHING

Silicone beading is sewn around the perimeter of the fabric graphic. Silicone beading is hidden from view once installed.

## DISPLAY CONSTRUCTION

Aluminum frame and components

## SHIPPING WEIGHTS & DIMENSIONS (FREIGHT ONLY)

Shipping Weight	999lbs (frame & graphics in crate)
Shipping Dimensions	103"L x 44"W x 58"H (in crate)

## GRAPHIC TURN AROUND TIME

5 business days after proof approval

AVAILABILITY	CA only
--------------	---------

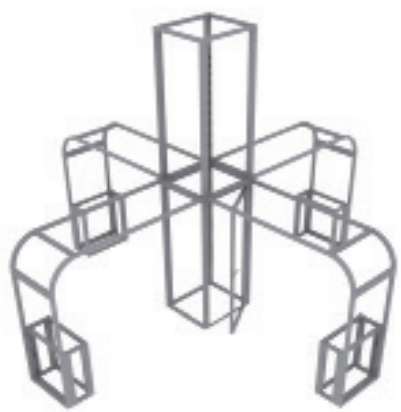

FRAME ONLY

## PARTS LIST

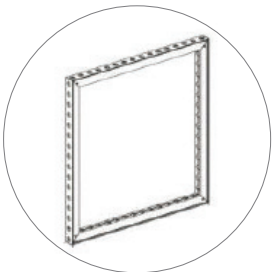

(qty 11)  
MOD-FRM-992x2418

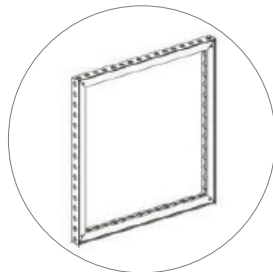

(qty 8)  
MOD-FRM-992x992

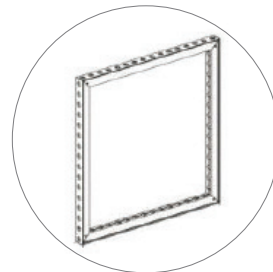

(qty 4)  
MOD-FRM-992x1984

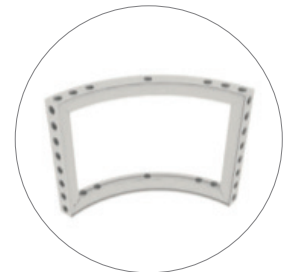

(qty 4)  
MOD-CRVFRM-774x992

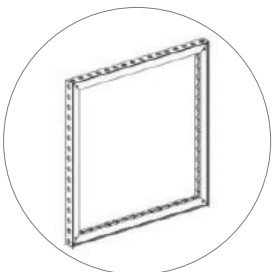

(qty 8)  
MOD-FRM-310x992

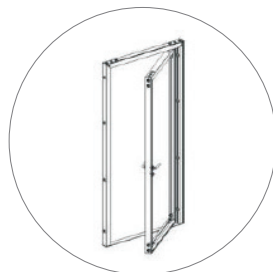

(qty 1)  
MOD-DSWL-992x2418



(qty 16)  
MOD-SN28mm

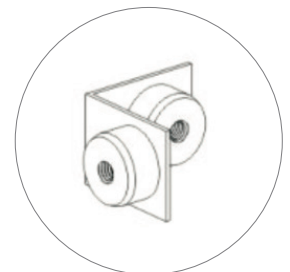

(qty 16)  
MOD-90D-CON

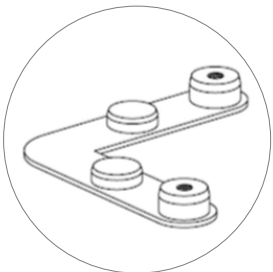

(qty 16)  
MOD-SM90D-CON

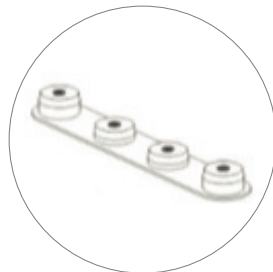

(qty 8)  
MOD-CRV-180DCL

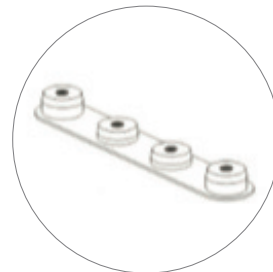

(qty 8)  
MOD-CRV-180DCR



(qty 2)  
MOD-CP-3100 (78")



(qty 4)  
MOD-CP-3100 (39")

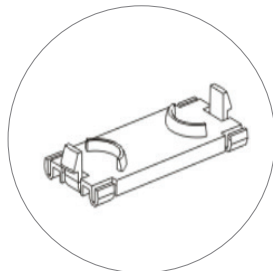

(qty 36)  
MOD-CC

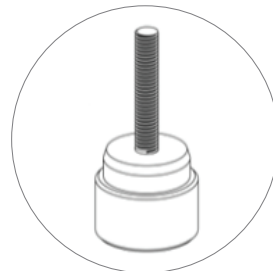

(qty 140)  
MOD-PC



(qty 8)  
MOD-CP-774



(qty 16)  
MOD-PCWP-B



(qty 4)  
MOD-PCWP-A

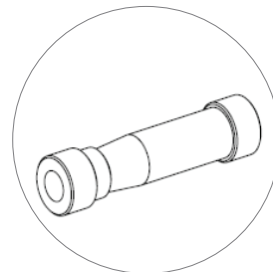

(qty 8)  
MOD-CLA-CON



(qty 8)  
MOD-CP-992x2418

## SET UP INSTRUCTIONS

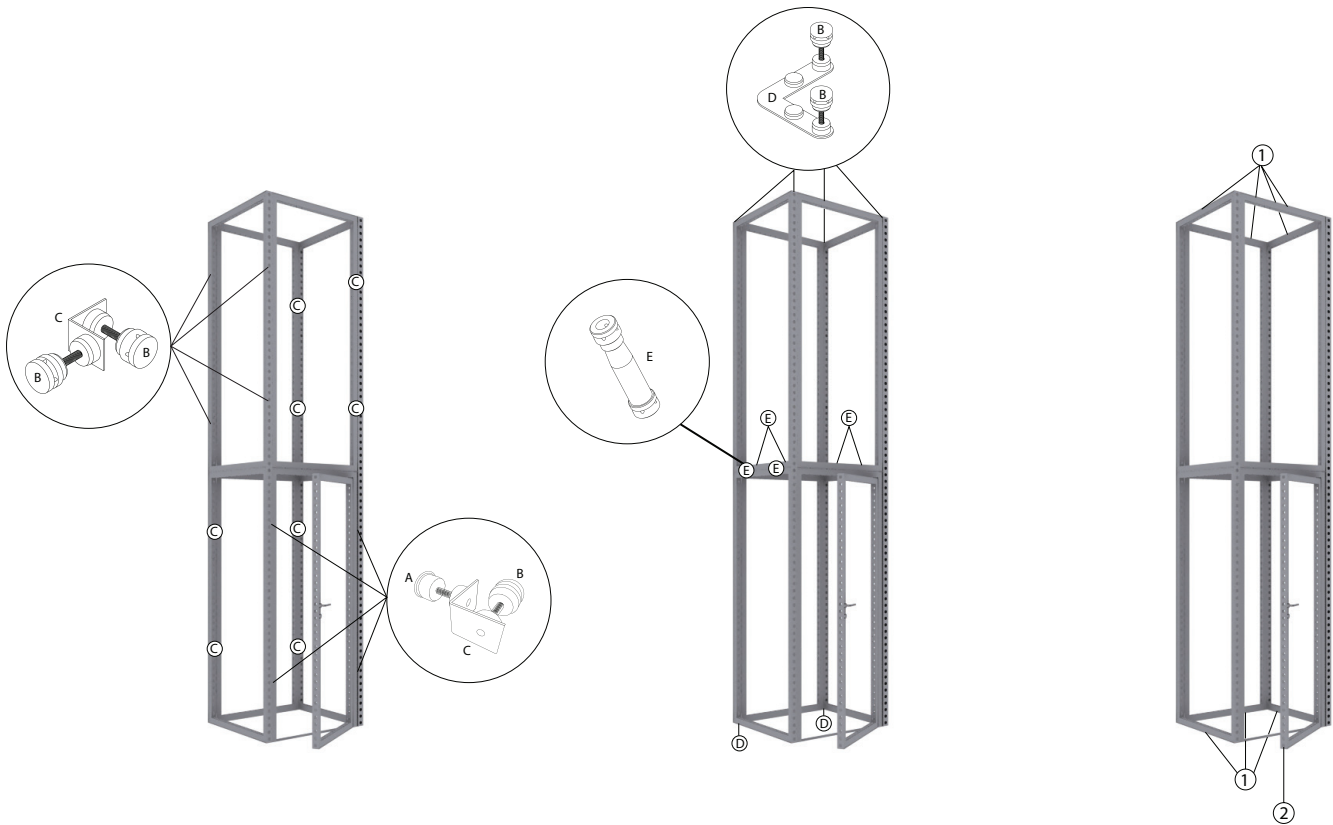

PARTS LIST (TOWER)			
REF	QTY	PART NO.	DESCRIPTION
A	4	MOD-PCWP-A	Pin Connector for Door Jamb
B	44	MOD-PC	Pin Connector
1	7	MOD-FRM-992x2418	Straight Frame, Corner Screw Connect 992mm x 2418mm
2	1	MOD-DSWL-992x2418	Door Set w/ Lock 992mm x 2418mm
C	16	MOD-90D-CON	90° Connector
D	8	MOD-SM90D-CON	Small 90° Connector
E	8	MOD-CLA-CON	Clamp Connector

## SET UP INSTRUCTIONS

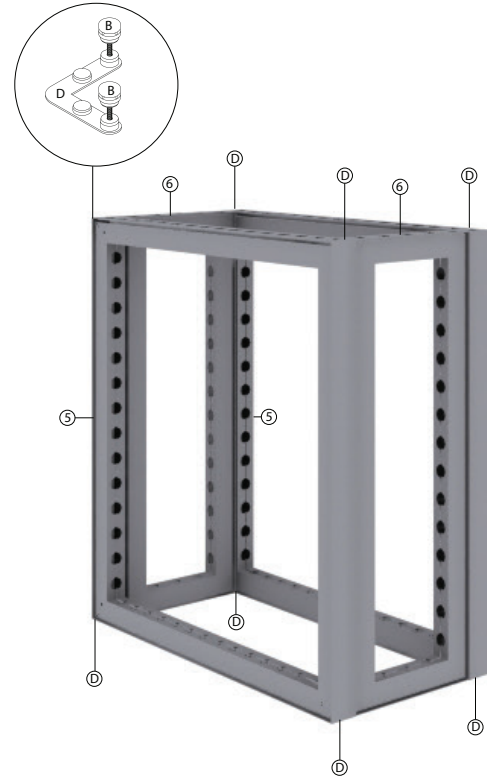
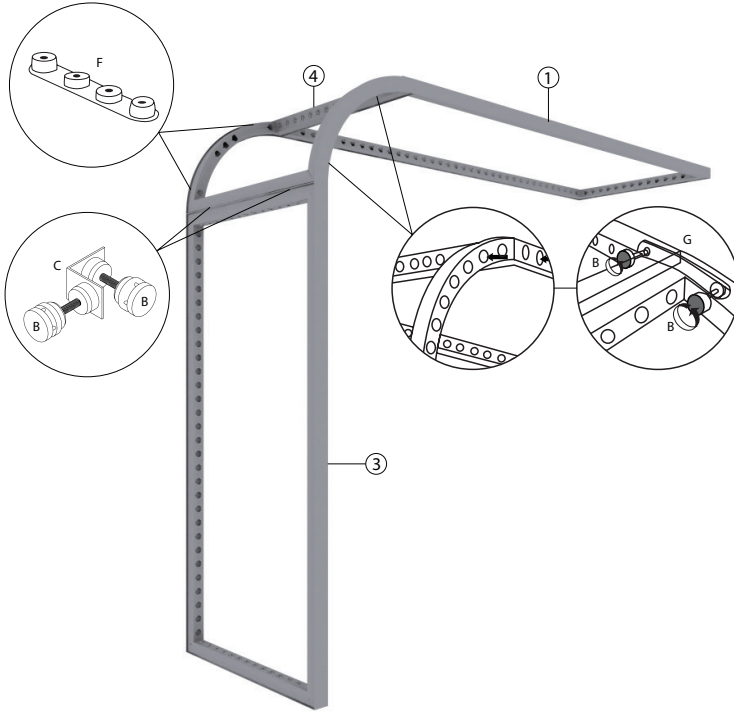

PARTS LIST (ARCH / Qty.4 TOTAL)			
REF	QTY	PART NO.	DESCRIPTION
1	4	MOD-FRM-992x2418	Straight Frame, Corner Screw Connect 992mm x 2418mm
3	4	MOD-FRM-992x1984	Straight Frame, Corner Screw Connect 992mm x 1984mm
4	4	MOD-CRVFRM-774x992	1/4 Curved Frame, Welded 774mm x 992mm
B	64	MOD-PC	Pin Connector
C	16	MOD-90D-CON	90° Connector
F	8	MOD-CRV-180DCL	Curve 180 Degree Connector (Left)
G	8	MOD-CRV-180DCR	Curve 180 Degree Connector (Right)

PARTS LIST (COUNTER / Qty.4 TOTAL)			
REF	QTY	PART NO.	DESCRIPTION
5	8	MOD-FRM-992x992	Straight Frame, Corner Screw Connect 992mm x 992mm
6	8	MOD-FRM-310x992	Straight Frame, Corner Screw Connect 310mm x 992mm
D	8	MOD-SM90D-CON	Small 90° Connector
B	16	MOD-PC	Pin Connector

## SET UP INSTRUCTIONS

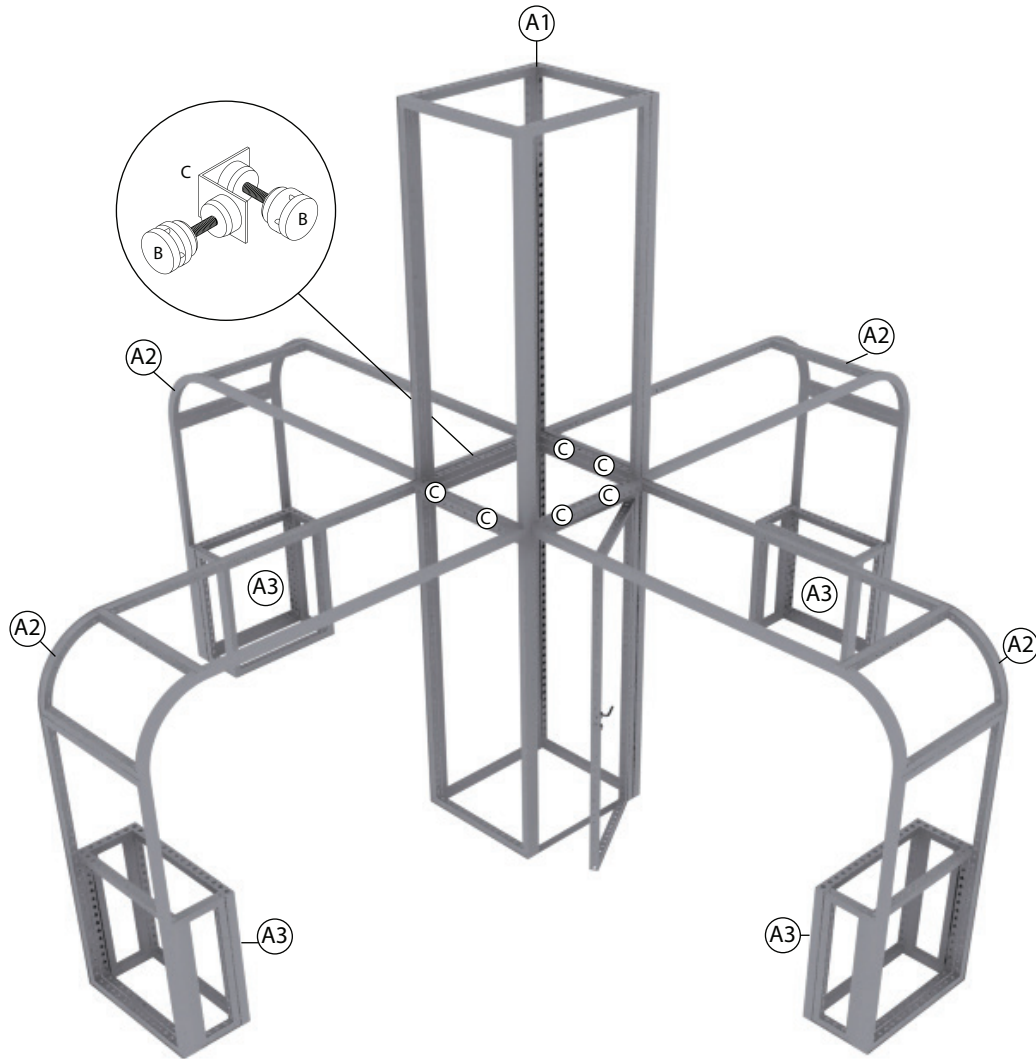

COMPLETE BUILD			
REF	QTY	PART NO.	DESCRIPTION
A1	1	N/A	TOWER
A2	4	N/A	ARCH
A3	4	N/A	COUNTER (DOES NOT CONNECT TO ARCH)
C	8	MOD-90D-CON	90° Connector
B	16	MOD-PC	Pin Connector

## SET UP INSTRUCTIONS

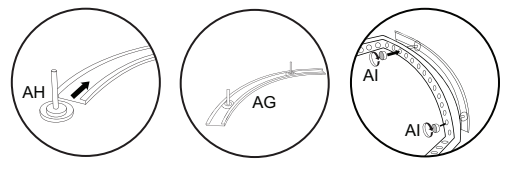
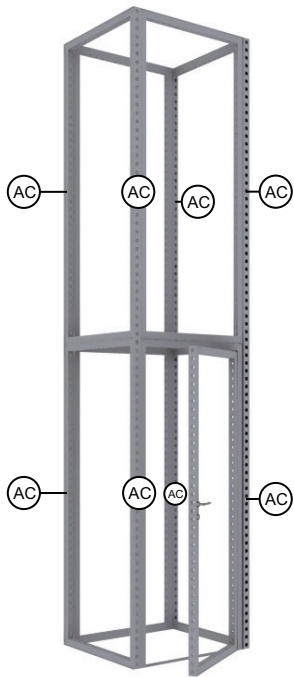
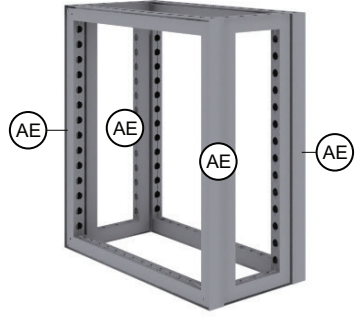
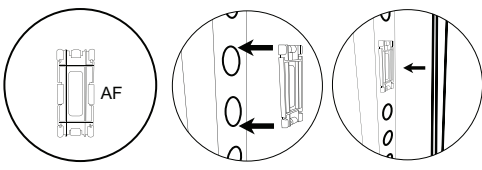

COVER PROFILES			
REF	QTY	PART NO.	DESCRIPTION
AC	8	MOD-CP-992x2418	Cover Profile for Frame 992x2418, Flat Model, Anodized
AF	36	MOD-CC	Clip Connector Cover Connects Cover Profile
AE	4	MOD-CP-3100 (39")	39" Cover Profile, Bar Per 3100mm Cover Profile, Flat Model, Anodized
AE	2	MOD-CP-3100 (78")	78" Cover Profile, Bar Per 3100mm Cover Profile, Flat Model, Anodized
AG	8	MOD-CP-774	Curved Cover profile 774mm(R1/4)
AH	16	MOD-PCWP-B	Pin connector(use with profile cover)
AI	16	MOD-SN-28MM	28mm screw nut

## GRAPHIC INSTALLATION

**Graphic Install**



Place graphic over the front of the frame.



Begin inserting SEG beading at each corner.

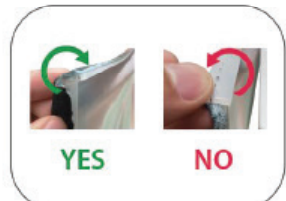

Insert the silicone beading with the fabric folded over. The silicone beading should not be exposed.

**YES** **NO**

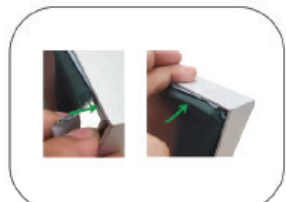

Using your fingers, push both fabric and silicone beading completely into the extrusions channel.

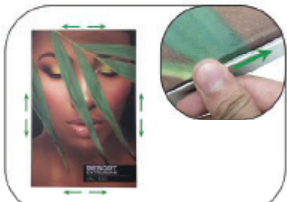

Continue to push in the remaining silicone beading on each side.



Check the perimeter of the frame for any excess beading that hasn't been pushed in. Graphic should be taut.