

# MODCO4-10X10

MODCO MODULAR EXHIBITS

PRODUCT CODE: MODCO4-10x10G



On frame On graphic



FRONT

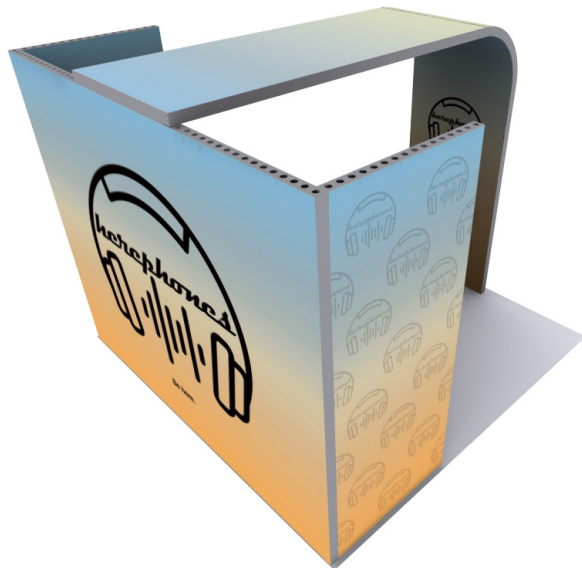

BACK

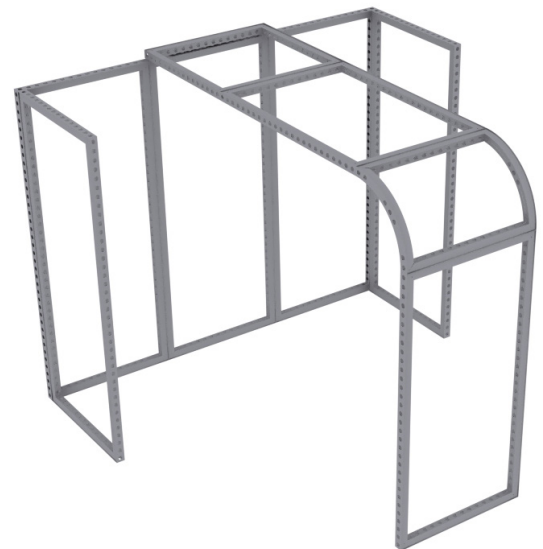
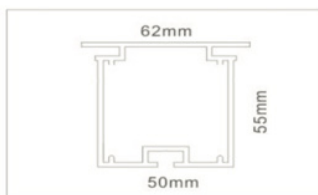
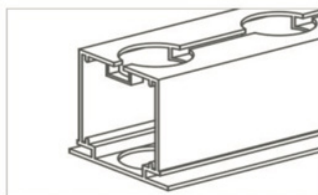

FRAME ONLY

## PRODUCT DESCRIPTION

Modco Modular Exhibits Modular 6 is a three-dimensional 10' x 10' pre-designed exhibit booth. Stylish and lively, Modco Modular Exhibits Modular 6 is built using tool-free perforated modular aluminum frames. Multiple size frames connect using simple toolless pin connectors. Customize double-sided stretch fabric SEG graphics for the entire exhibit. Perforations are completely covered for a flawless finish.

DISPLAY DIMENSIONS	117.375"W x 97.9"H x 117.5"D		
GRAPHIC SIZES	PANEL	SIZE	QTY
	A	40.125"W x 96.25"H	4
	B	40.125"W x 109.125"	2
	C	40.125"W x 98.75"	2
	D	118.375"W x 96.25"H	2
TOTAL PRINTS			10

## GRAPHIC MATERIAL

Dye Sub Fabric

## GRAPHIC FINISHING

Silicone beading is sewn around the perimeter of the fabric graphic. Silicone beading is hidden from view once installed.

## DISPLAY CONSTRUCTION

Aluminum frame and components

## SHIPPING WEIGHTS & DIMENSIONS (FREIGHT ONLY)

Shipping Weight	lbs (frame & graphics in crate)
Shipping Dimensions	103"L x 44"W x 58"H (in crate)

## GRAPHIC TURN AROUND TIME

5 business days after proof approval

AVAILABILITY	CA only
--------------	---------

## PARTS LIST

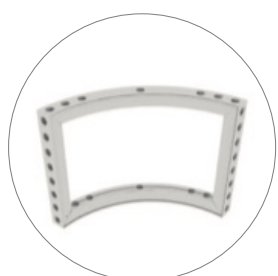

(qty 1)  
MOD-CRVFRM-774x992

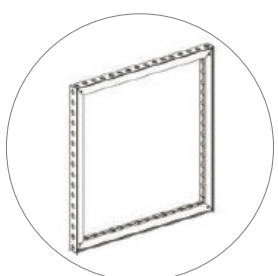

(qty 6)  
MOD-FRM-992x2418

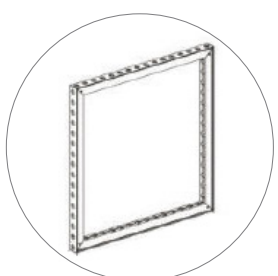

(qty 1)  
MOD-FRM-992x1984

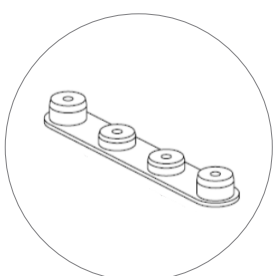

(qty 4)  
MOD-180D-CON

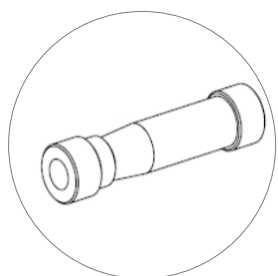

(qty 4)  
MOD-CLA-CON

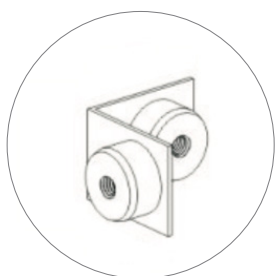

(qty 10)  
MOD-90D-CON

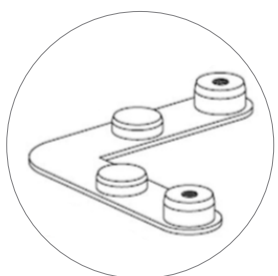

(qty 4)  
MOD-SM90D-CON



(qty 2)  
MOD-CP-3100

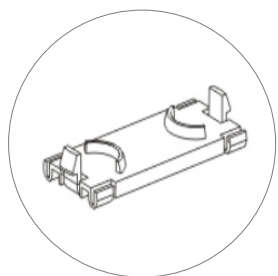

(qty 22)  
MOD-CC



(qty 2)  
MOD-CP-774

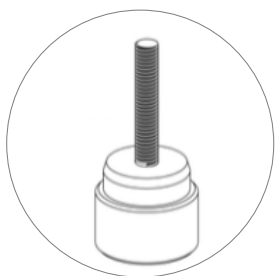

(qty 48)  
MOD-PC



(qty 4)  
MOD-SN28MM

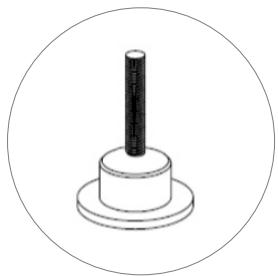

(qty 4)  
MOD-PCWP-B

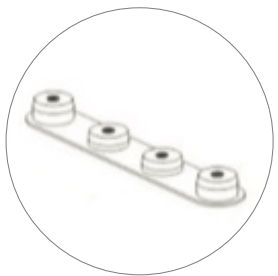

(qty 2)  
MOD-CRV-180DCL

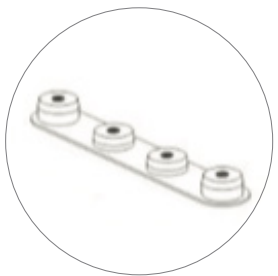

(qty 2)  
MOD-CRV-180DCR

## SET UP INSTRUCTIONS

### MODCO 4-10x10

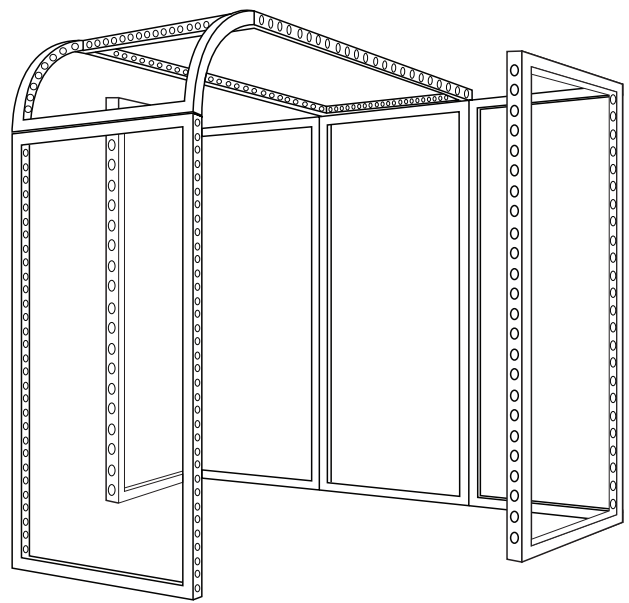

Instructions

### Parts / Frames

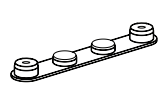

**180° Connector**  
MOD-180D-CON  
Qty.4

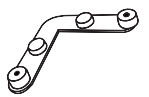

**Small 90° Connector**  
MOD-SM90D-CON  
Qty.4



**Pin Connector**  
MOD-PC  
Qty.48



**Door Pin Connector**  
MOD-PCDOOR  
Qty.4

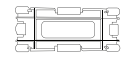

**Clip Connector**  
MOD-CC  
Qty.22

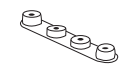

**180° Curved Connector**  
MOD-CRV-180DCL Qty.2  
MOD-CRV-180DCR Qty.2

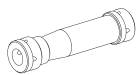

**Clamp Connector**  
MOD-CLA-CON  
Qty.4



**90° Connector**  
MOD-90D-CON  
Qty.10



**1/4 Curved Cover Profile**  
MOD-CP-774  
Qty.2



**58° / 78° Cover Profile**  
MOD-CP-3100  
Qty.2 - 58° / Qty.2 - 78°



**95° Cover Profile**  
MOD-CP-3100  
Qty.4



**Pin Connector for Profile Cover**  
MOD-PCWP-B  
Qty.4



**28mm Screw Nut**  
MOD-SN28MM  
Qty.4

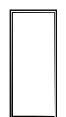

**992 x 1984**  
MOD-FRM-992x1984  
Qty.1

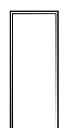

**992 x 2418**  
MOD-FRM-992x2418  
Qty.6



**992 x 992**  
MOD-CRVFRM-774x992  
Qty.1

### Connections I

# A

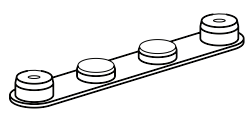

MOD-180D-CON / MOD-PC

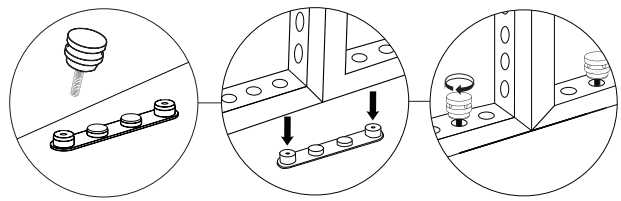

# B

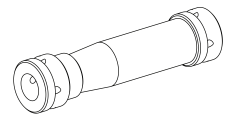

MOD-CLA-CON

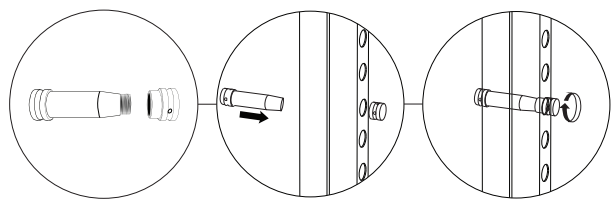

# C

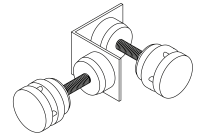

MOD-90D-CON + MOD-PC

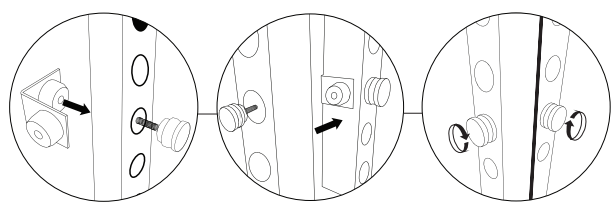

### Connections II

# D

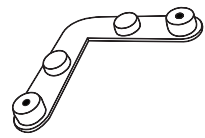

MOD-SM90D-CON / MOD-PC

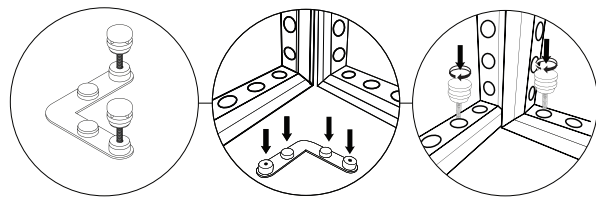

# E

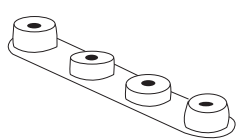

MOD-CRV-180DC / LEFT & RIGHT

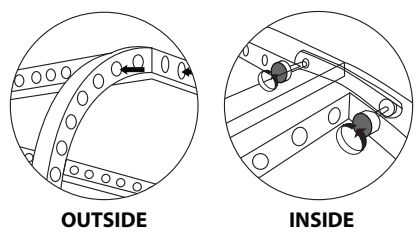

# F

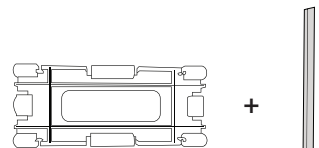

MOD-CC / MOD-CP-3100

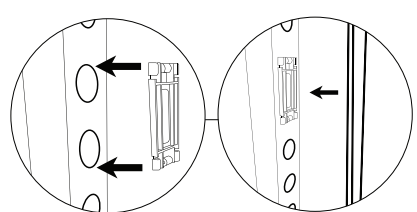

### Connections III

# G

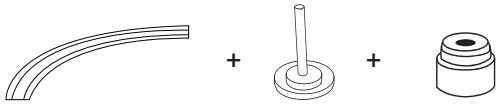

MOD-CP-774      MOD-PCWP-B      MOD-SN28MM

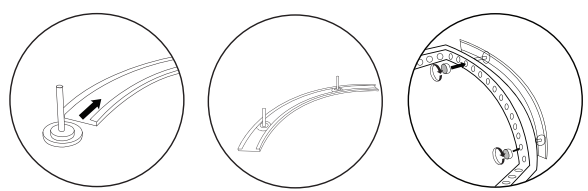

# 1

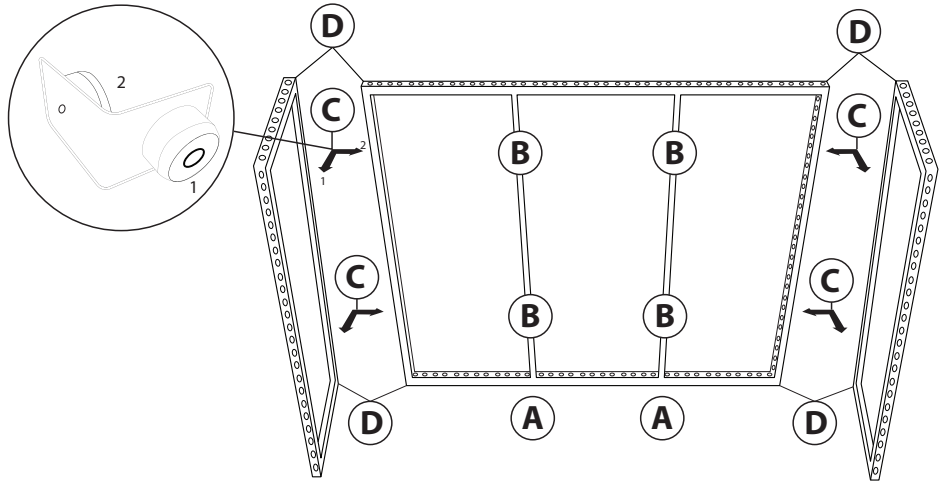

Attach (3) MOD-FRM-992x2418 in a row.  
Next, attach (1) MOD-FRM-992x2418 to each adjacent side of the row - (2) sides total.  
Reference the diagram above.

**2**

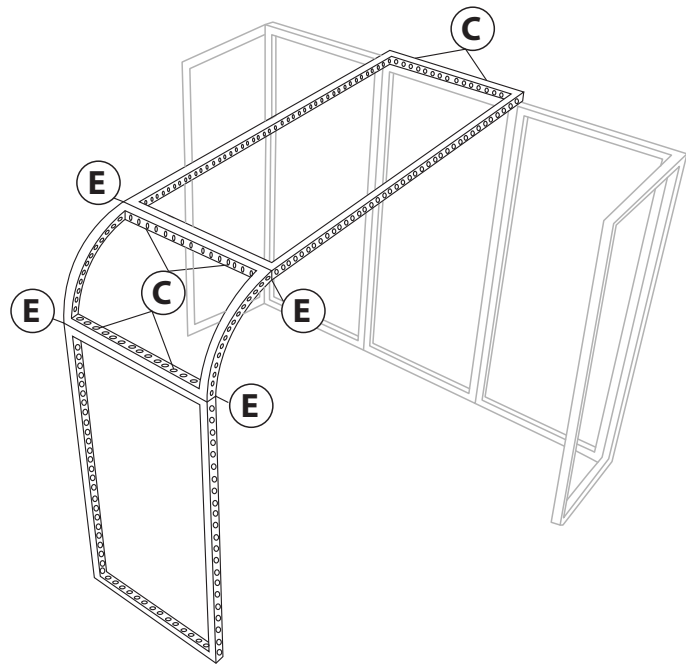

**Cover Profiles**

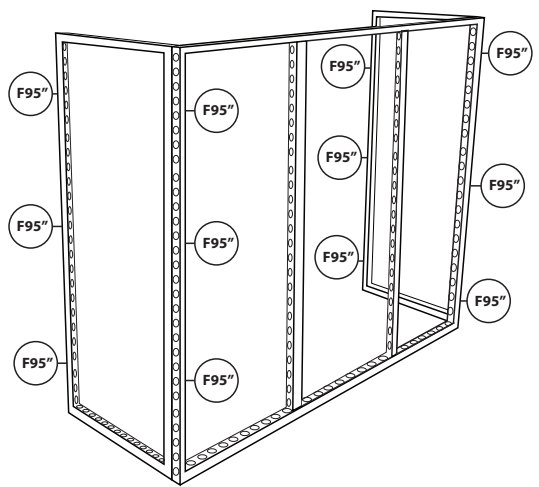
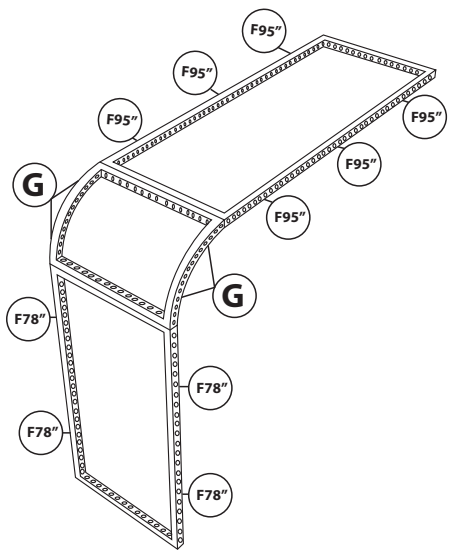

Snap in clip connectors at each designated point and then  
 reference the measurement and install the cover profile.  
 \*Overhead view - clip connectors/cover profiles to back side of configuration.

**Graphic Install**



Place graphic over the front of the frame.



Begin inserting SEG beading at each corner.

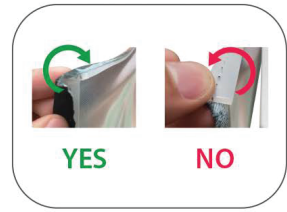

Insert the silicone beading with the fabric folded over. The silicone beading should not be exposed.

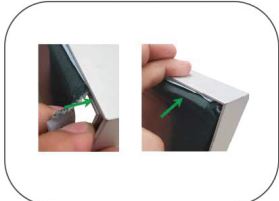

Using your fingers, push both fabric and silicone beading completely into the extrusions channel.

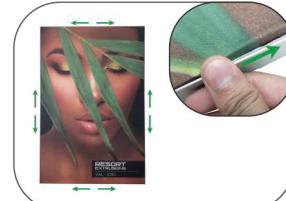

Continue to push in the remaining silicone beading on each side.



Check the perimeter of the frame for any excess beading that hasn't been pushed in. Graphic should be taut.